



ROMP

Frame

Houten constructie van beuken regels gecombineerd met multiplex plaat-materiaal.

Vering

No-sag veren.

Schuim

In de zitting met een natuurlijke vallende worden drie verschillende kwaliteiten HR-schuim gebruikt. De basis is een zacht polyurethaan schuim (soortelijk gewicht 40kg/m³) voor het zit-comfort. Aan de voorkant is een stevige spie (soortelijk gewicht 45kg/m³) geplaatst voor een goede knieholte ondersteuning en voorkomt dat men uit de bank „glijdt“. Het geheel wordt met een superzachte schuim afgedekt. Het rug- en armgedeelte aan de binnenkant van de bank bestaat uit twee kwaliteiten HR-schuim. Het achterste gedeelte is een harder schuim. Het voorste gedeelte een zachter polyurethaan schuim. De resterende schuimdelen bestaan uit verschillende hardere en zachtere kwaliteiten polyether schuimkwaliteiten. Het geheel wordt afgedekt met een superzacht schuim-dek en 200 grams dacron.

STOFFERING

Stof of leer. De AZTEC is in het geval van een stoffen hoes geheel afneembaar. De leren hoezen worden vastgeniet. Stoffen moeten een minimale breedte (excl. zelfkant) van 1,35m hebben om te kunnen worden verwerkt op de AZTEC.

POTEN

Zwarte kunststof poten voorzien van een rubberen doppen.

BRANDVEILIG

De AZTEC banken zijn te verkrijgen in British Standard 5852, part 1 en 2, en CA, TB 117-2013

BODY

Frame

Wooden construction of beech rows combined with plywood plate material.

Suspension

No-sag springs.

Foam

Three different grades of HR foam are used in the naturally-sloping seat. The base is of soft polyurethane foam (specific weight 40 kg/m³) for sitting comfort. A sturdy spline (specific weight 45 kg/m³) is fitted at the front for good knee support and to prevent "sliding" off the couch. The whole unit is covered with an exceptionally soft foam. The back and arm section on the inside of the sofa consists of two grades of HR foam. The rear section is of harder foam. The front section is of softer poly-urethane foam. The remaining foam sections consist of various harder and softer grades of polyether foam grades. The whole unit is covered with an exceptionally soft foam cover and 200 grams of Dacron.

UPHOLSTERY

Fabric or leather. The AZTEC is completely removable in the case of a fabric cover. The leather covers are stapled. Fabrics must have a minimum width (excluding selvedge) of 1.35 m in order to be processed on the AZTEC.

LEGS

Black plastic legs with rubber caps.

FIREPROOF

The AZTEC sofas are available in British Standard 5852, part 1 and 2, and CA, TB 117-2013

KORPUS

Rahmen

Holzkonstruktion aus Buchenlatten und Multiplex-Platten.

Federung

Nosagfedern.

Schaumfüllung

Für die Sitzfläche mit einer natürlichen Neigung werden drei verschiedene Sorten HR-Schaum verarbeitet. Als Basis dient ein weicher PUR-Schaum mit einer Dichte von 40 kg/m³, der für den Sitzkomfort sorgt. Ein stabiler Keil (Dichte 45 kg/m³) an der Vorderseite unterstützt die Kniekehle und verhindert, dass man vom Sofa rutscht. Dies alles ist mit einem sehr weichen Schaum abgedeckt. Die Rücken- und Armlehnen an der Innenseite des Sofas bestehen aus zwei Sorten HR-Schaum. Im hinteren Bereich ist ein härterer Schaum verarbeitet und im vorderen Bereich ein weicherer PUR-Schaum. Die übrigen Schaumteile bestehen aus verschiedenen härteren oder weicheren Sorten PE-Schaum. Dies alles ist mit einer sehr weichen Schaumschicht und Dacron (200 g/m²) abgedeckt.

BEZUG

Stoff oder Leder. Der Stoff-bezug des AZTEC kann vollständig abgenommen werden. Die Lederbezüge werden festgenietet. Um die Stoffe auf dem AZTEC verarbeiten zu können, müssen sie eine Mindestbreite von 1,35 m zzgl. Webkante besitzen.

FÜSSE

Schwarze Kunststofffüße mit Gummikappen.

BRANDSCHUTZ

Die AZTEC-Sofas erfüllen die Normen BS 5852, Teil 1 und 2 sowie CA, TB 117-2013.

AZTEC

Gerard van de Berg 1981/2019

SCHOUDERKUSSEN

Het schouderkussen kan op elke rug van de AZTEC worden geplaatst. Door de anti-slip aan de onderkant en het gewicht wordt het kussen op zijn plaats gehouden. Afhankelijk van de stoffering op de bank kan het schouderkussen tijdens gebruik zich verplaatsen. Dat is onvermijdelijk. Het wordt daarom ook afgeraden om het schouderkussen op een leren bank of op hele gladde stoffen te gebruiken.

STOFFERING

Het schouderkussen is alleen in stof verkrijgbaar. Het kussen kan op twee manieren worden bekleed: met of zonder ribbels. De geribbelde versie heeft de beperking dat deze alleen gemaakt kan worden van de volgende stoffen:

Montis Aldo
Montis Allegra
Montis Amaro
Montis Bryna
Montis Fidal
Montis Mellow
Montis Orsetto
Kvadrat Sahco Baru
Kvadrat Gentle
Kvadrat Sahco Moss
Kvadrat Sahco Safire
De Ploeg Monza
De Ploeg Monza Melange

De stoffering is afneembaar. Hier-voor dient eerst de metalen onderplaat die voorzien is van anti-slip te worden losgeschroefd.

CONSTRUCTIE

Het schouderkussen is opgebouwd om een metalen frame met aan de zijkanten twee multiplex plaatjes. Daartussen is een HR schuim met een soortelijk gewicht van $55\text{kg}/\text{m}^3$ gebruikt. De stoffering is voorzien van een polyurethaan schuim en wordt bij de ribbelvariant door-gestikt. Aan de onderzijde is een metalen plaat voorzien van anti-slip materiaal vastgeschroefd.

SHOULDER CUSHION

The shoulder cushion can be placed on any back of the AZTEC. The anti-slip underside and the weight keeps the cushion in place. Depending on the upholstery on the sofa, the shoulder cushion can move during use. This is unavoidable. It is therefore not recommended to use the shoulder cushion on a leather sofa or on very smooth fabrics.

UPHOLSTERY

The shoulder cushion is only produced in fabric. The cushion can be upholstered in two ways: with or without ribbing. For the ribbed version, there is the restriction that it can only be made in the following fabrics:

Montis Aldo
Montis Allegra
Montis Amaro
Montis Bryna
Montis Fidal
Montis Mellow
Montis Orsetto
Kvadrat Sahco Baru
Kvadrat Gentle
Kvadrat Sahco Moss
Kvadrat Sahco Safire
De Ploeg Monza
De Ploeg Monza Melange

The upholstery is removable. To remove the upholstery, first un-screw the metal bottom plate, which is provided with anti-slip coating.

CONSTRUCTION

The shoulder cushion is built around a metal frame with two plywood plates on the sides. In between HR foam with a specific weight of $55\text{kg}/\text{m}^3$ is used. The upholstery is made of polyurethane foam and is quilted in the ribbed version. A metal plate with non-slip material is screwed to the underside.

SCHULTERKISSEN

Das Schulterkissen kann auf jeder Rückseite des AZTEC angebracht werden. Die rutschfeste Unterseite und das Gewicht halten das Kissen an seinem Platz. Je nach Polsterung des Sofas kann sich das Schulterkissen während der Benutzung bewegen. Dies ist unvermeidlich. Es wird daher nicht empfohlen, das Schulterkissen auf einem Ledersofa oder auf sehr glatten Stoffen zu verwenden.

POLSTERMÖBEL

Das Schulterkissen wird nur in Stoff hergestellt. Das Kissen kann auf zwei Arten gepolstert werden: mit oder ohne Rippung. Für die gerippte Version gilt die Einschränkung, dass sie nur aus den folgenden Stoffen hergestellt werden kann:

Montis Aldo
Montis Allegra
Montis Amaro
Montis Bryna
Montis Fidal
Montis Mellow
Montis Orsetto
Kvadrat Sahco Baru
Kvadrat Gentle
Kvadrat Sahco Moss
Kvadrat Sahco Safire
De Ploeg Monza
De Ploeg Monza Melange

Die Polsterung sind abnehmbar. Dazu muss die Bodenplatte aus Metall, die mit einer rutschfesten Unterlage versehen ist, zunächst abgeschraubt werden.

KONSTRUKTION

Das Schulterkissen ist um einen Metallrahmen mit zwei Sperrholzplatten an den Seiten aufgebaut. Dazwischen wird HR-Schaum mit einem spezifischen Gewicht von $55\text{kg}/\text{m}^3$ verwendet. Die Polsterung besteht aus Polyurethanschaum und ist in der gerippten Version gesteppt. An der Unterseite ist eine Metallplatte mit rutschfestem Material angeschraubt.

AZTEC

Gerard van de Berg 1981/2019



AZTEC

Gerard van de Berg 1981/2019



AZTEC

Gerard van de Berg 1981/2019



plain shoulder cushion



ribbed shoulder cushion

AZTEC

Gerard van de Berg 1981/2019



AZTEC

Gerard van de Berg 1981/2019

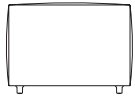

1,5-Z

168 cm / 66.1"
90 cm / 35.4"

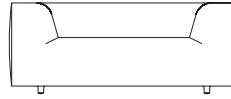

1,5-Z

44 cm / 17.3"
68 cm / 26.8"

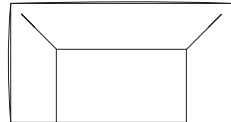

56 cm / 22.1"
90 cm / 35.4"
9.5 cm / 3.74"

2,5-Z

203 cm / 80"
125 cm / 49.2"

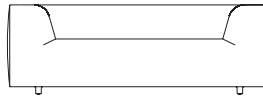

2,5-Z

44 cm / 17.3"
68 cm / 26.8"

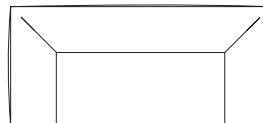

56 cm / 22.1"
90 cm / 35.4"
9.5 cm / 3.74"

3-Z

228 cm / 89.8"
150 cm / 59.1"

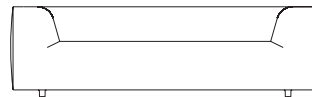

3-Z

44 cm / 17.3"
68 cm / 26.8"

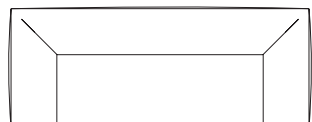

56 cm / 22.1"
90 cm / 35.4"
9.5 cm / 3.74"

3,5-Z

253 cm / 99.6"
175 cm / 68.9"

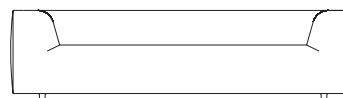

3,5-Z

44 cm / 17.3"
68 cm / 26.8"



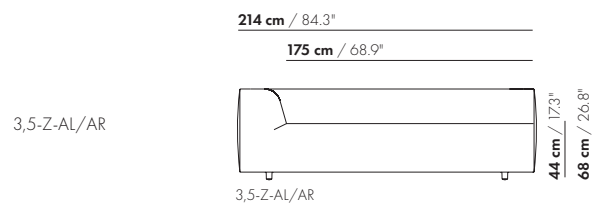
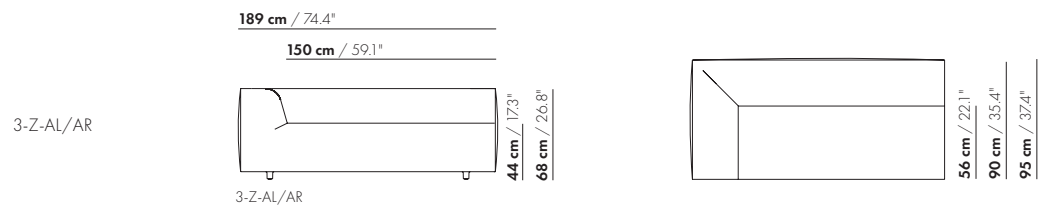
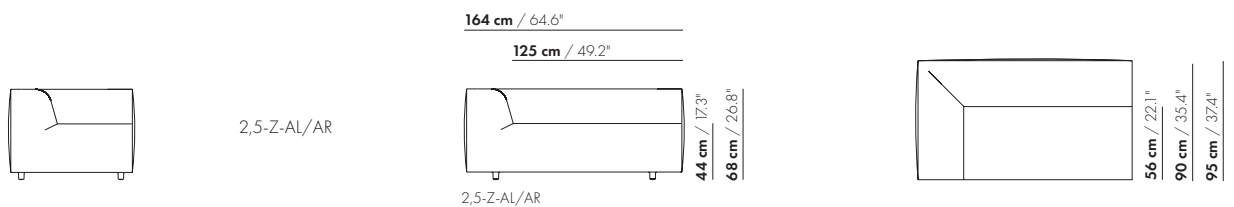
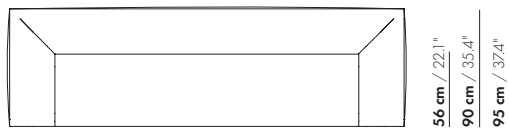
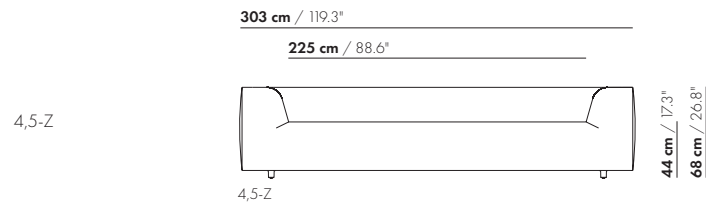
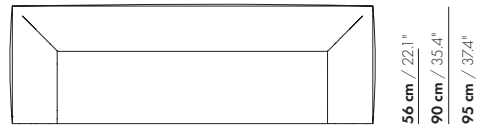
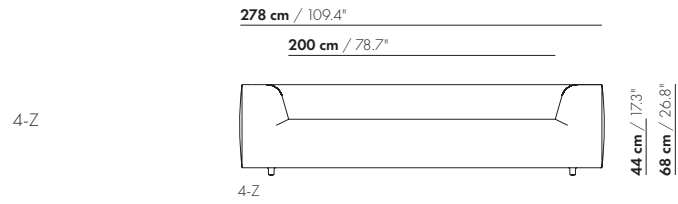

AZTEC

Gerard van de Berg 1981/2019

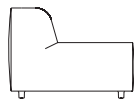
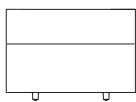
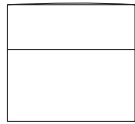
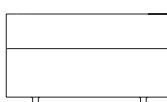
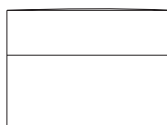
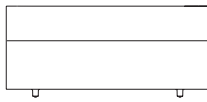
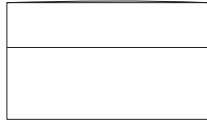
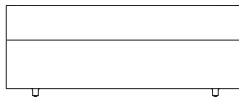
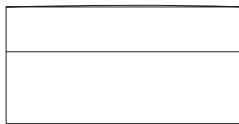

AZTEC

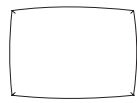
Gerard van de Berg 1981/2019

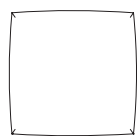
	1,5-Z-ZA	<p><u>90 cm / 35.4"</u></p>  <p>1,5-Z-ZA</p>	 <p><u>56 cm / 22.1"</u> <u>90 cm / 35.4"</u> <u>95 cm / 37.4"</u></p>
	2,5-Z-ZA	<p><u>125 cm / 49.2"</u></p>  <p>2,5-Z-ZA</p>	 <p><u>56 cm / 22.1"</u> <u>90 cm / 35.4"</u> <u>95 cm / 37.4"</u></p>
	3-Z-ZA	<p><u>150 cm / 59.1"</u></p>  <p>3-Z-ZA</p>	 <p><u>56 cm / 22.1"</u> <u>90 cm / 35.4"</u> <u>95 cm / 37.4"</u></p>
	3,5-Z-ZA	<p><u>175 cm / 68.9"</u></p>  <p>3,5-Z-ZA</p>	 <p><u>56 cm / 22.1"</u> <u>90 cm / 35.4"</u> <u>95 cm / 37.4"</u></p>
	P-60X90	<p><u>44 cm / 17.3"</u></p>  <p>P-60X90</p>	<p><u>95 cm / 37.4"</u> <u>90 cm / 35.4"</u></p>  <p><u>60 cm / 23.6"</u> <u>65 cm / 25.6"</u></p>
	P-90X90	<p><u>44 cm / 17.3"</u></p>  <p>P-90X90</p>	<p><u>95 cm / 37.4"</u> <u>90 cm / 35.4"</u></p>  <p><u>90 cm / 35.4"</u> <u>95 cm / 37.4"</u></p>

AZTEC

Gerard van de Berg 1981/2019

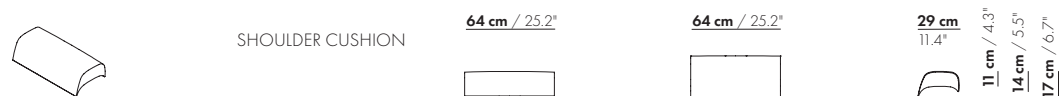
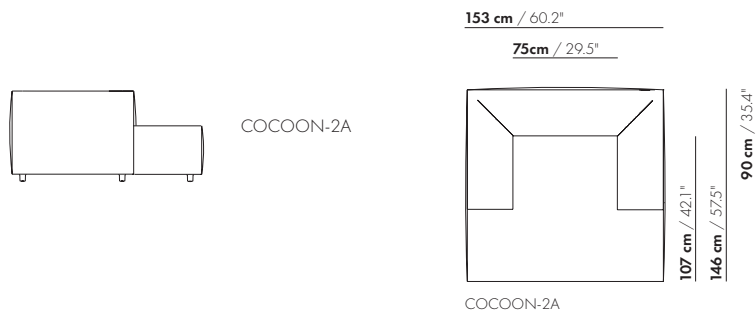
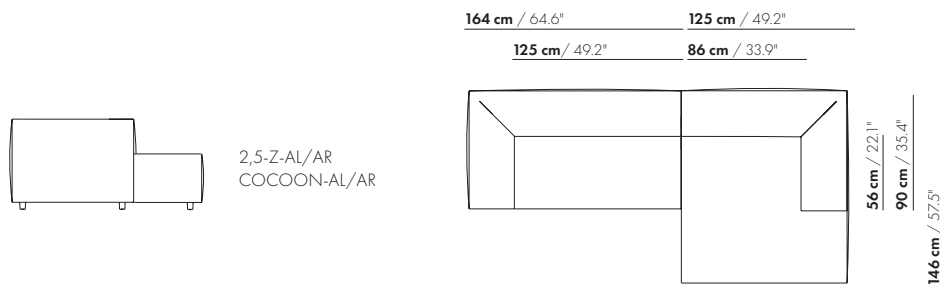
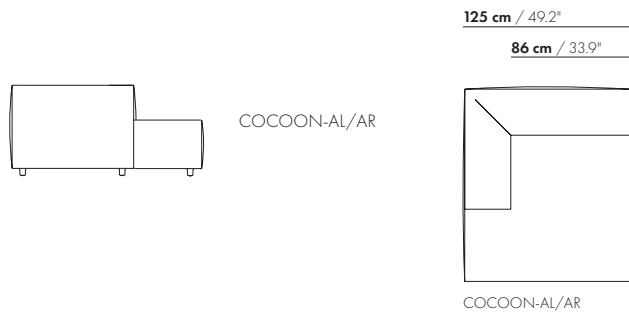

AZTEC

Gerard van de Berg 1981/2019

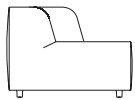

H-30-L/R

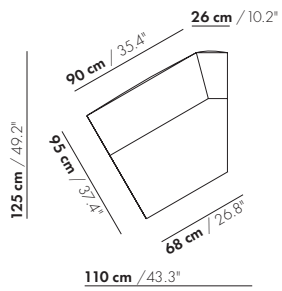

H-30-L

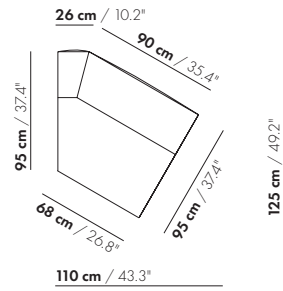

H-30-R

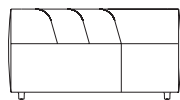

H-CLOSED-90

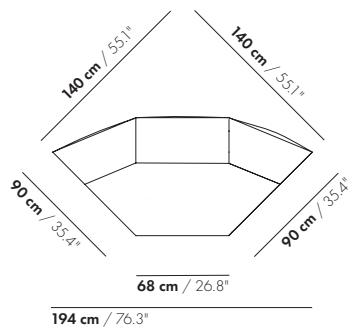

56 cm / 22.1"
90 cm / 35.4"
95 cm / 37.4"

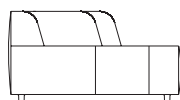

H-OPEN-90

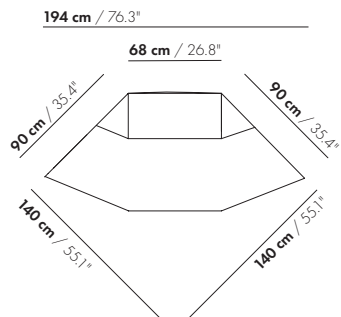

56 cm / 22.1"
90 cm / 35.4"
95 cm / 37.4"

AZTEC XL

Gerard van de Berg 1981/2019



1,5-Z

168 cm / 66.1"
90 cm / 35.4"

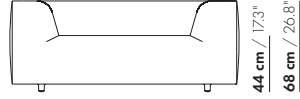

1,5-Z

44 cm / 17.3"
68 cm / 26.8"

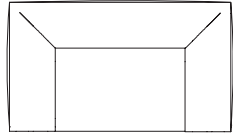

64 cm / 25.2"
98 cm / 38.6"
103 cm / 40.5"

2,5-Z

203 cm / 80"
125 cm / 49.2"

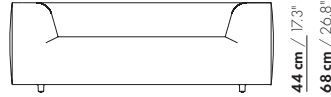

2,5-Z

44 cm / 17.3"
68 cm / 26.8"

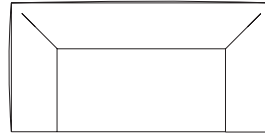

64 cm / 25.2"
98 cm / 38.6"
103 cm / 40.5"

3-Z

228 cm / 89.8"
150 cm / 59.1"

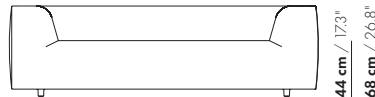

3-Z

44 cm / 17.3"
68 cm / 26.8"

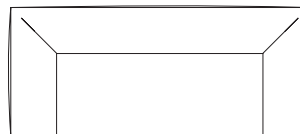

64 cm / 25.2"
98 cm / 38.6"
103 cm / 40.5"

3,5-Z

253 cm / 99.6"
175 cm / 68.9"

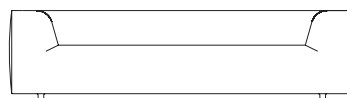

3,5-Z

44 cm / 17.3"
68 cm / 26.8"

AZTEC XL

Gerard van de Berg 1981/2019

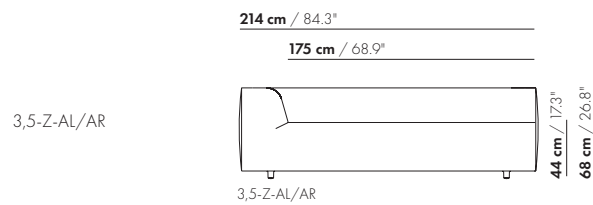
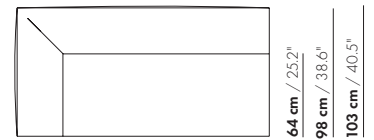
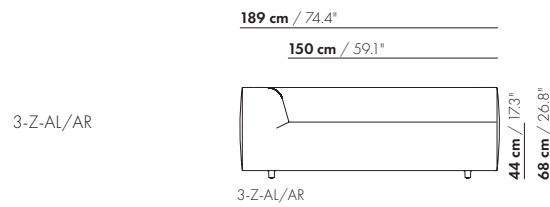
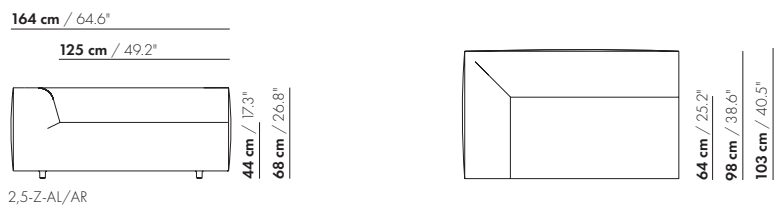
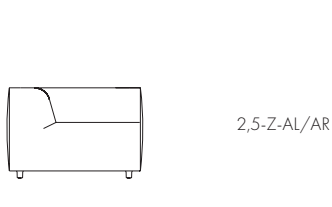
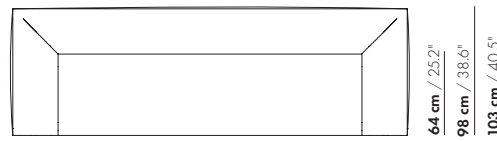
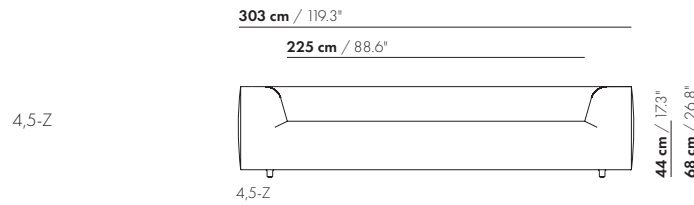
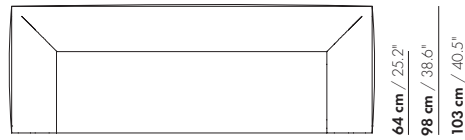
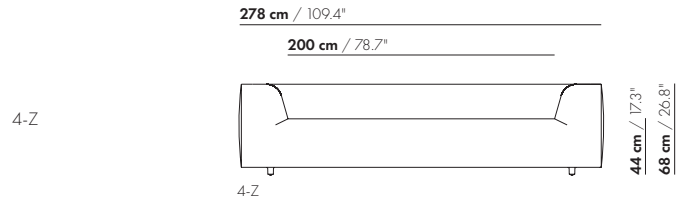

AZTEC XL

Gerard van de Berg 1981/2019

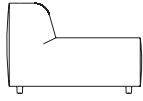

1,5-Z-ZA

90 cm / 35.4"

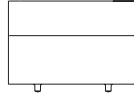

1,5-Z-ZA

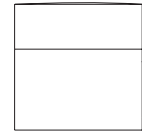

64 cm / 25.2"
98 cm / 38.6"
103 cm / 40.5"

2,5-Z-ZA

125 cm / 49.2"

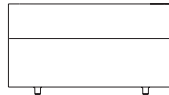

2,5-Z-ZA

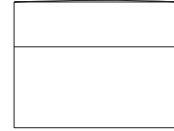

64 cm / 25.2"
98 cm / 38.6"
103 cm / 40.5"

3-Z-ZA

150 cm / 59.1"

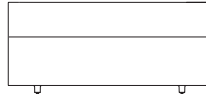

3-Z-ZA

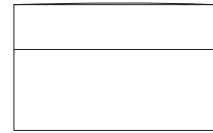

64 cm / 25.2"
98 cm / 38.6"
103 cm / 40.5"

3,5-Z-ZA

175 cm / 68.9"

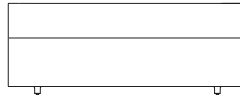

3,5-Z-ZA

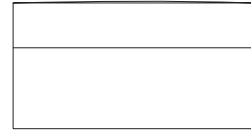

64 cm / 25.2"
98 cm / 38.6"
103 cm / 40.5"



P-60X98



P-60X98

44 cm / 17.3"

98 cm / 38.6"

103 cm / 40.5"

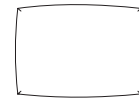

60 cm / 23.6"
65 cm / 25.6"

P-98X98



P-98X98

44 cm / 17.3"

98 cm / 38.6"

103 cm / 40.5"

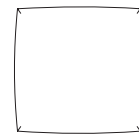

98 cm / 38.6"
103 cm / 40.5"

AZTEC XL

Gerard van de Berg 1981/2019

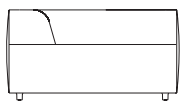

CHL-AL/AR

125 cm / 49.2"
86 cm / 33.9"

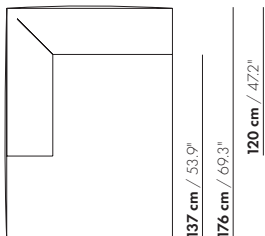

CHL-AL/AR

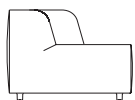

H-30-L/R

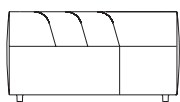
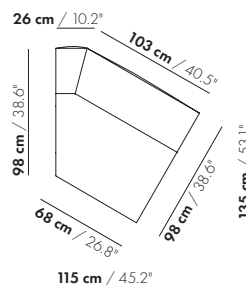
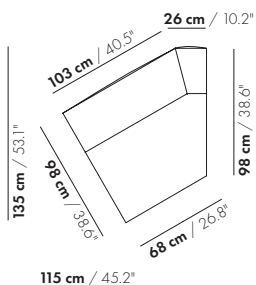

H-CLOSED-90

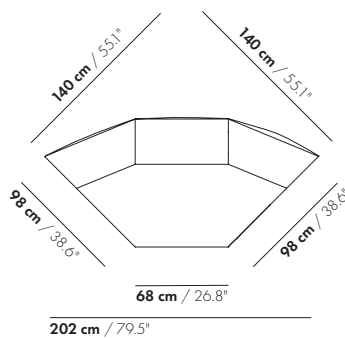

64 cm / 25.2"
98 cm / 38.6"
103 cm / 40.5"

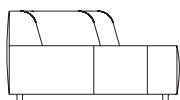

H-OPEN-90

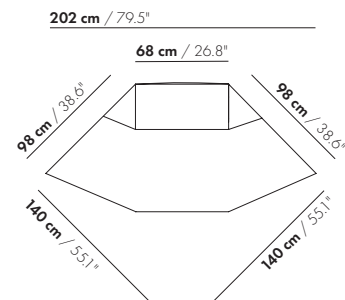

64 cm / 25.2"
98 cm / 38.6"
103 cm / 40.5"